

540951-900

Max cutting thickness: 18mm

Max cutting length: 900mm

Spring-loaded working tables

Sliding system with 9 ball bearings

Large adjustable ruler

2 breakers: 1 small and 1 large

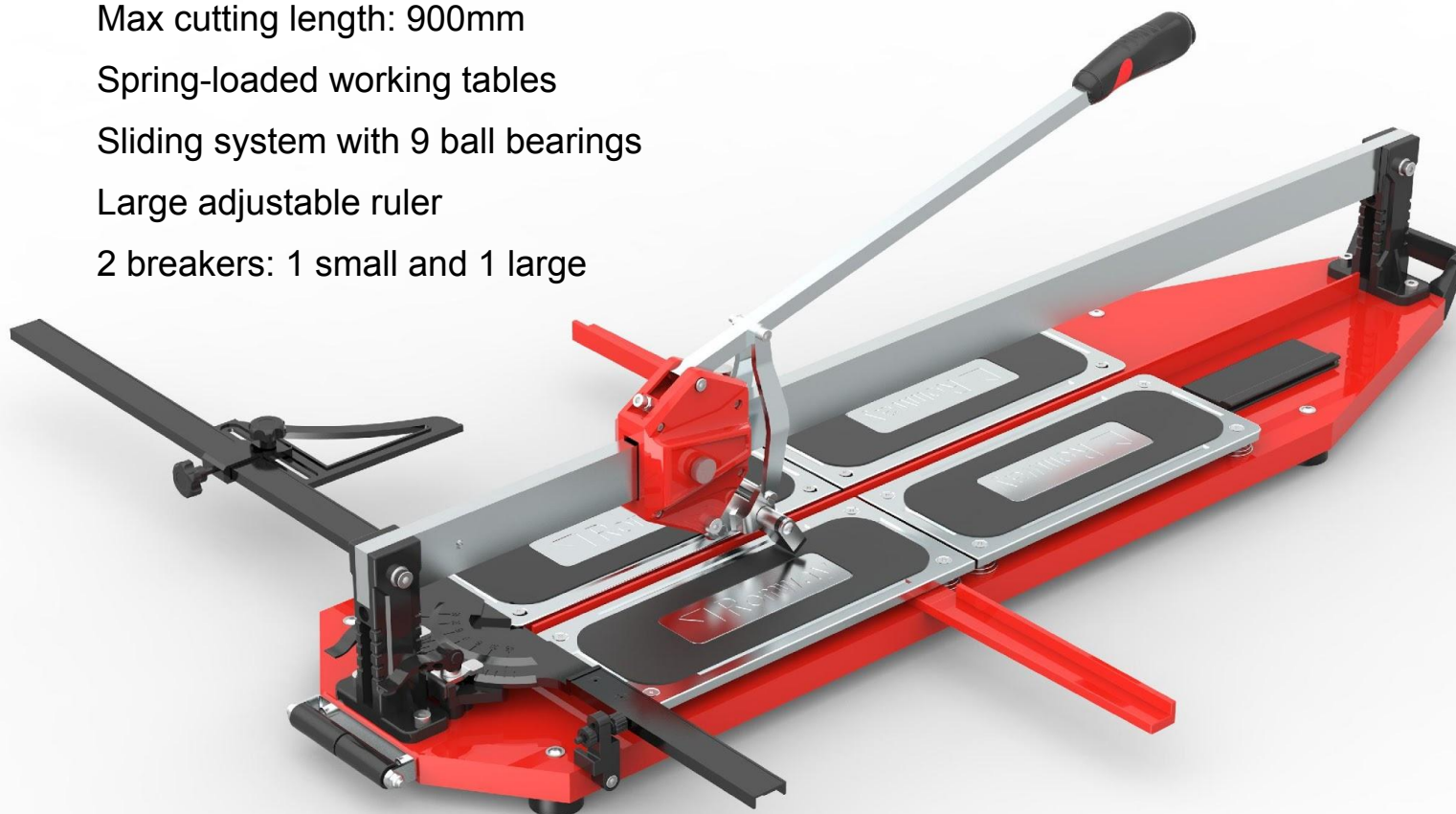

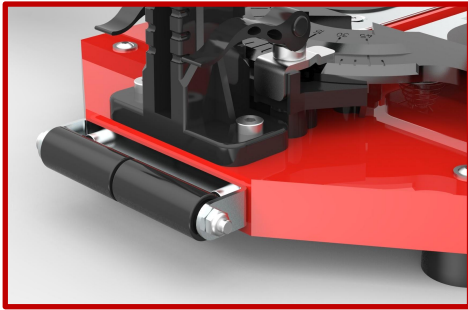

Moving rollers



45X15mm strong rail

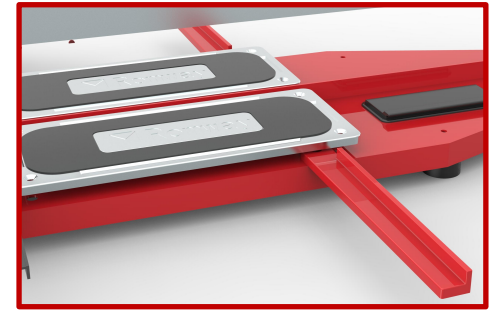

Lateral extension bars

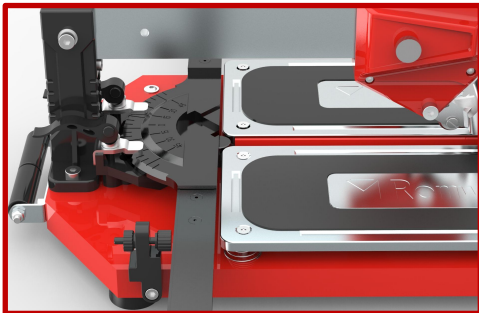

Ruler with fast clamps



Tool box

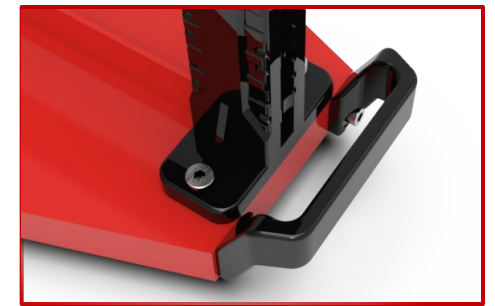

Moving handle





Easy adjustment of the sliding carriage

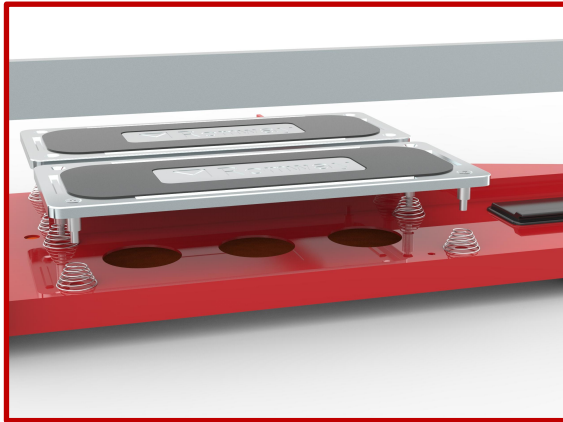

Spring-loaded working tables



Easy adjustment of the handle



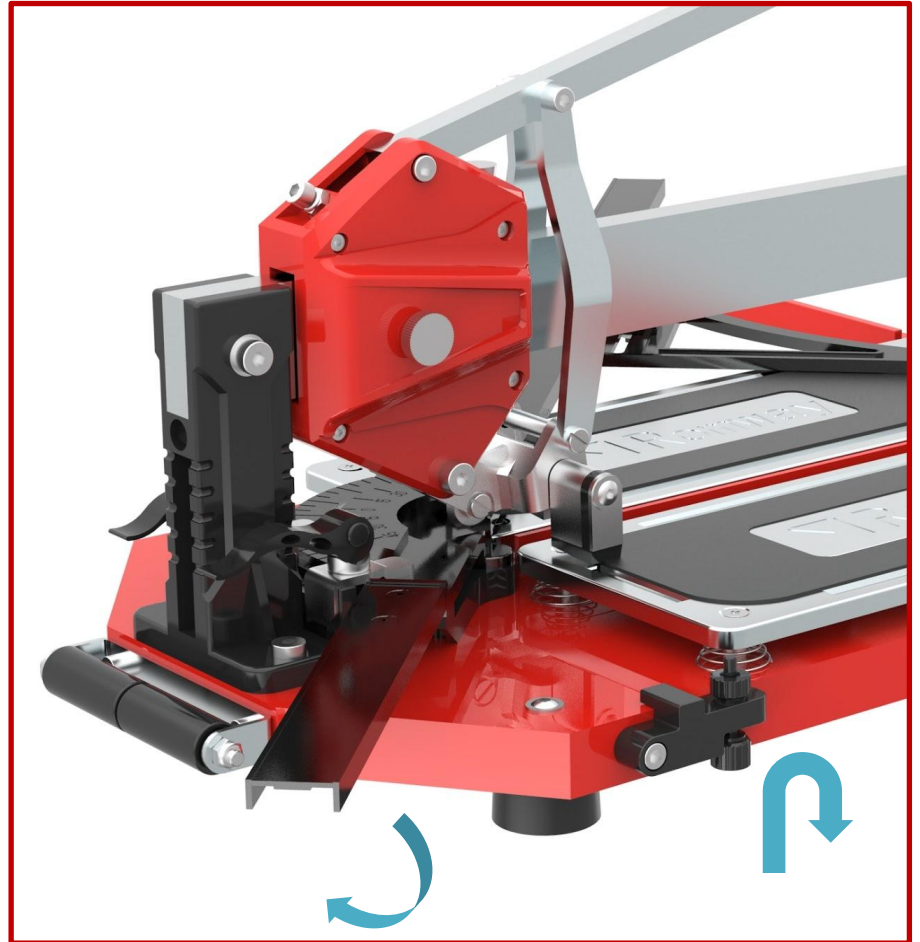

Adjust pivoting ruler to cut different angles on both sides



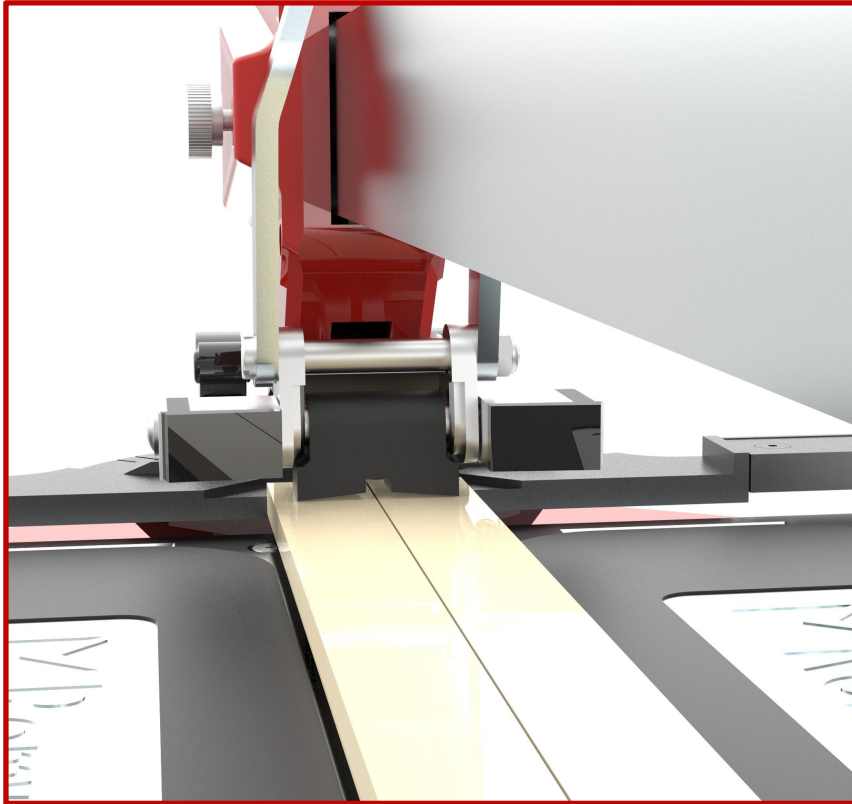

Small breaker for cutting thin and narrow tiles

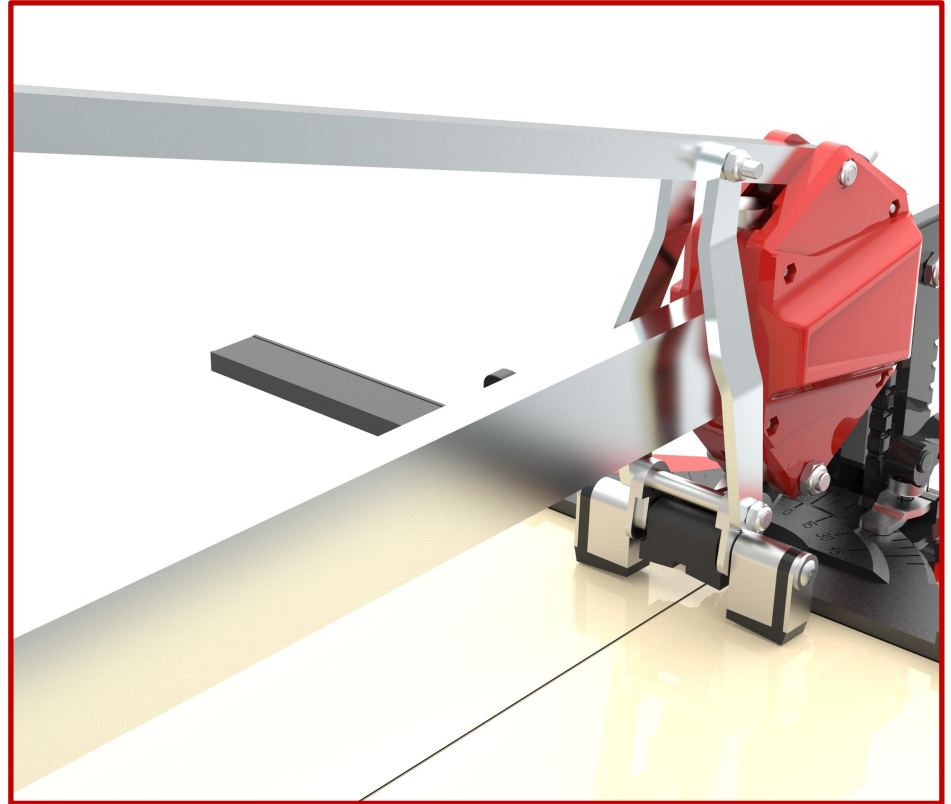

Large breaker for cutting thick and large tiles, and for diagonal cutting

